

料号 Part NO.	品名/型号 Parts Name
34-HIWA-DLCBS-4-01	PC板间隔柱 DLCBS-4-01

PCB  $\varnothing 4.0$

thickness 厚度: 0.79-1.98

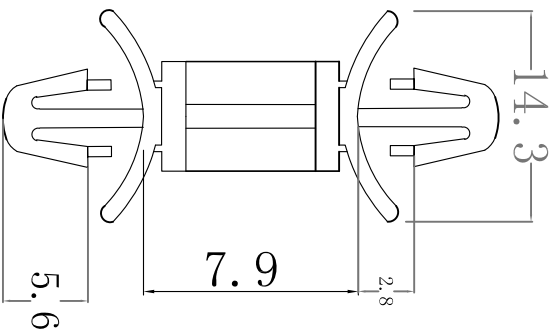

用途: 用于PC板间隔柱, 无工具, 容易拆卸;  
 材质: NYLON66(UL)  
 防火等级: 94V-2  
 颜色: 本色  
 公差要求: 未标注公差 $\pm 0.5$

PCB  $\varnothing 4.0$   
 thickness 厚度: 0.79-1.98



未经并受权不得修改和复印  
 该知识产权属于技术质量部;

DIMENSION	TOLERANCES								
0.0 0.00	$\pm 0.50$								
FIRST ANGLE PROJ		A	NEW PART	<i>sullivan</i>	<i>34-wang</i>	<i>2020/05</i>	DWG. BY	CHK. BY	DATE
		LTR.	REVISION RECORD						
		DWG. BY	<i>liu liang</i>	UNIT	mm	CHK. BY	<i>sullivan</i>	REV.	A
		APP. BY	<i>wang yanyan</i>	DWG. NO.	HIWA/QR-JZ-34 -HIWA-DLCBS-4-01				

**HIWA** 惠华  
 苏州惠华电子科技有限公司