

| | | | |
|----------------|------------------|------|-----|
| 料号 Part NO. | 品名 Parts Name | A | B |
| 34-TP2.6-16 | 塑胶铜柱 TP2.6-16 | 16.0 | 5.0 |

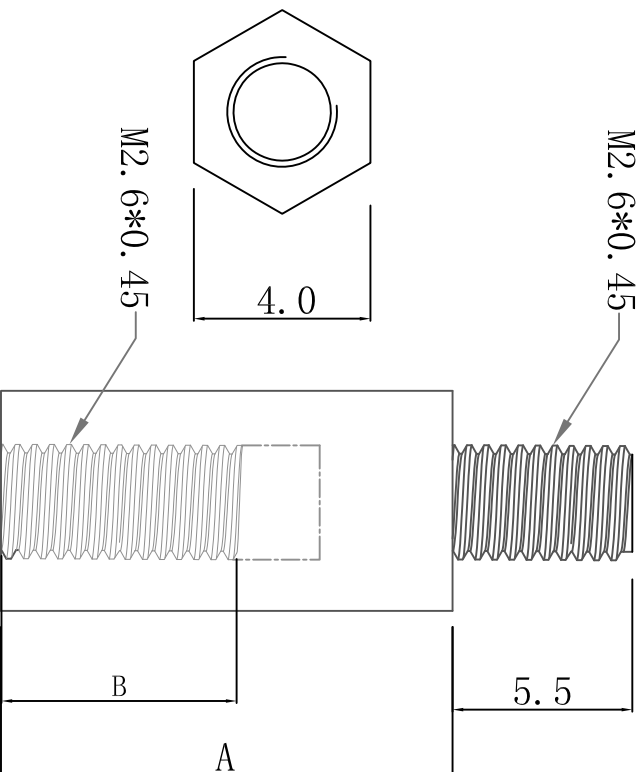

◆ MATERIAL: NYLON66 (UL) 94V-2
◆ UNIT: mm
用途: 做为PC板与机板间之固定, 六角型不滑动。



未经授权不得修改和复印
该知识产权属于技术质量部;

| DIMENSION | | TOLERANCES | | FIRST ANGLE PROJ | | LTR. | NEW PART | DWG. BY | CHK. BY | DATE | |
|-----------|------------------|------------|----|------------------|----------------|------|----------|----------------|---------------------|----------------|------------------------|
| 0.0 | 0.00 | ±0.5 | | | | A | | <i>oullian</i> | <i>zy wang</i> | <i>2011/28</i> | |
| DWG. BY | <i>Lin Liang</i> | UNIT | mm | CHK. BY | <i>oullian</i> | REV. | A | APP. BY | <i>wang jiaqian</i> | DWG. NO. | HIMA/QR-JZ-34-TP2.6-16 |