

料号 Part NO.	品名 Parts Name	A	B(Inch)	C(Inch)	Pitch 孔距
74-HIWA-PN8-32	公制塑胶螺母	PN8-32	#8-32	0.13	0.335
					8-32

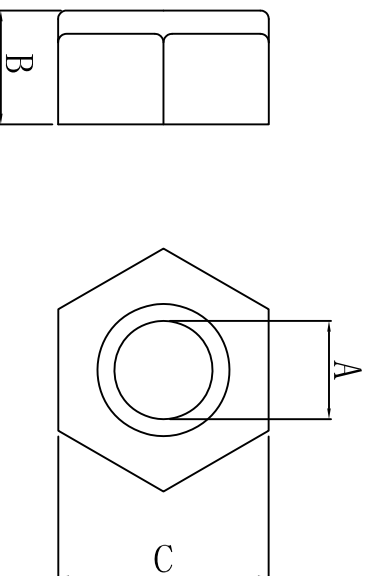

材质: 尼龙66;  
 规格等级: 94V-2  
 颜色: 本色 (本色)  
 用途: 机械固定, 螺丝固定  
 特点: 绝缘佳, 不生锈, 不腐蚀, 重量轻;



未经并受权不得修改和复印  
 该知识产权属于技术质量部;

DIMENSION	TOLERANCES									
0.0	±0.30									
0.00										
FIRST ANGLE PROJ		A	NEW PART	<i>william</i>	<i>ya wang</i>	<i>20108</i>				
		LTR.	REVISION RECORD	DWG. BY	CHK. BY	DATE				
DWG. BY	<i>lin liang</i>	UNIT	mm	CHK. BY	<i>william</i>	REV.	A	DWG. NO.	HIWA-QR-JZ-74 -HIWA-PN8-32	
APP. BY	<i>wang zhiyan</i>									



惠州惠华电子科技有限公司